

OUTLINE DIMENSIONAL DRAWING

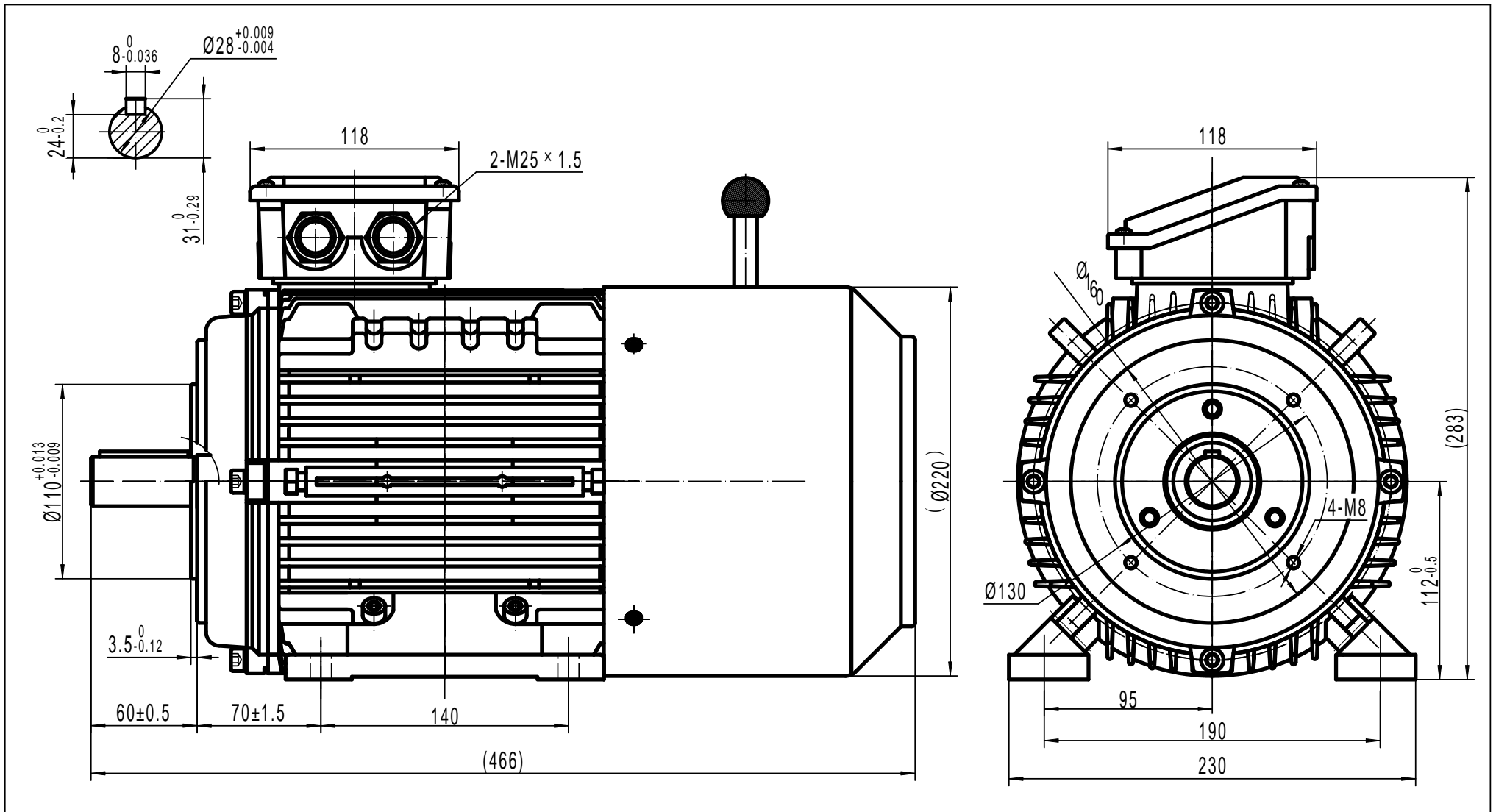

TECHTOP AUSTRALIA PTY LTD	
FRAME	TAIB 112A B34
DATE	DRAWING NO.
2013/10/22	1ST105.052.001-024 A